

# Introduction to MPI

*Martin Čuma*

*Center for High Performance  
Computing University of Utah  
m.cuma@utah.edu*

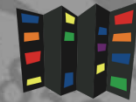

- Quick introduction (in case you slept/missed last time).
- MPI concepts, initialization.
- Point-to-point communication.
- Collective communication.
- Grouping data for communication.
- Quick glance at advanced topics.
- Survey

<https://www.surveymonkey.com/r/8GGBT78>



- Process has access only to its local memory
- Data between processes must be communicated
- More complex programming
- Cheap commodity hardware
- CHPC: Linux clusters

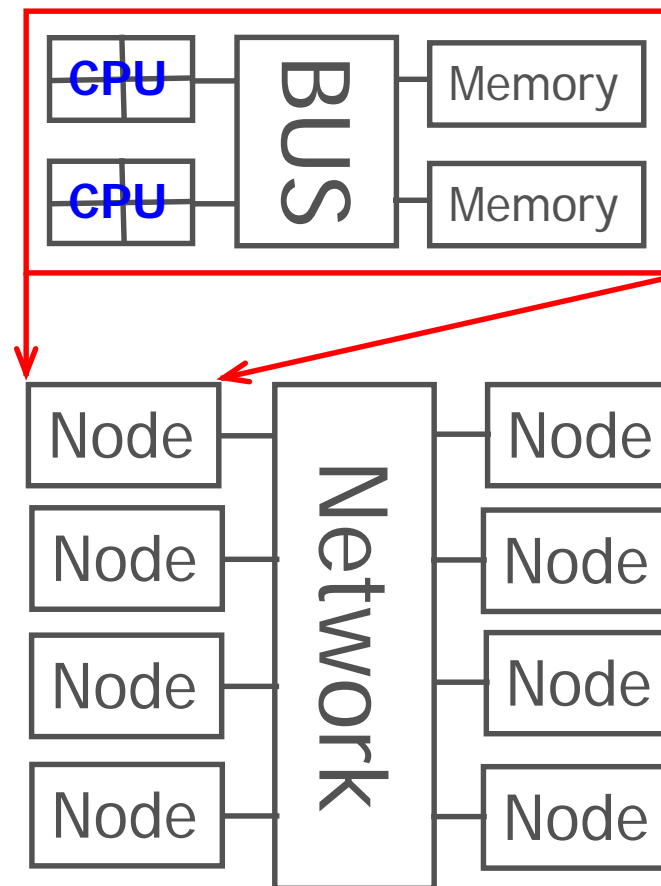

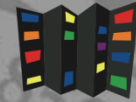

- Standardized message-passing library
  - uniform API
  - guaranteed behavior
  - source code portability
- Complex set of operations
  - various point-to-point communication
  - collective communication
  - process groups
  - processor topologies
  - one sided communication (RMA)
  - parallel I/O



```
program hello
integer i, n, ierr, my_rank, nodes
include "mpif.h"

call MPI_Init(ierr)
call MPI_Comm_size(MPI_COMM_WORLD,nproc,ierr)
call MPI_Comm_rank(MPI_COMM_WORLD,my_rank,ierr)
if (my_rank .eq. 0) then
  do i=1,nproc-1
    call MPI_Recv(n,1,MPI_INTEGER,i,0,MPI_COMM_WORLD,
&    status,ierr)
    print*, 'Hello from process',n
  enddo
else
  call MPI_Send(my_rank,1,MPI_INTEGER,0,0,MPI_COMM_WORLD,ierr)
endif
call MPI_Finalize(ierr)
return
```



```
ember1:~>%module load mpich
ember1:~>%mpif77 ex1.f -o ex1
em001:~>%srun -n 12 -N 1 -A chpc -p ember -t 1:00:00 -
pty=/bin/tcsh -l
em001:~%>mpirun -np 4 ex1
```

```
Hello from process      1
Hello from process      2
Hello from process      3
```

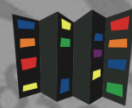

- must be `included` in subroutines and functions that use MPI calls
- provide required declarations and definitions
- Fortran – `mpif.h`
  - declarations of MPI-defined datatypes
  - error codes
- C – `mpi.h`
  - also function prototypes

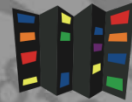

- Initializing MPI:
  - `MPI_Init(ierr)`
  - `int MPI_Init(int *argc, char **argv)`
- Terminating MPI
  - `MPI_Finalize(ierr)`
  - `int MPI_Finalize()`
- Determine no. of processes
  - `MPI_Comm_Size(comm, size, ierr)`
  - `int MPI_Comm_Size(MPI_comm comm, int* size)`
- Determine rank of the process
  - `MPI_Comm_Rank(comm, rank, ierr)`
  - `int MPI_Comm_Rank(MPI_comm comm, int* rank)`



- Sending data

- `MPI_Send(buf, count, datatype, dest, tag, comm, ierr)`
- `int MPI_Send(void *buf, int count, MPI_Datatype, int dest, int tag, MPI_comm comm)`  
call `MPI_Send(my_rank, 1, MPI_INTEGER, 0, 0, MPI_COMM_WORLD, ierr)`

- Receiving data

- `MPI_Recv(buf, count, datatype, source, tag, comm, status, ierr)`
- `int MPI_Recv(void *buf, int count, MPI_Datatype, int source, int tag, MPI_comm comm, MPI_Status status)`  
call `MPI_Recv(n, 1, MPI_INTEGER, i, 0, MPI_COMM_WORLD, status, ierr)`



- Data (buffer, count)
- Sender / Recipient
- Message envelope
  - data type – see next two slides
  - tag – integer to differentiate messages
  - communicator – group of processes that take place in the communication  
default group communicator – MPI\_COMM\_WORLD

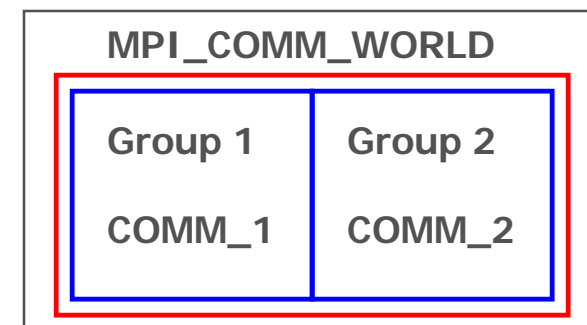
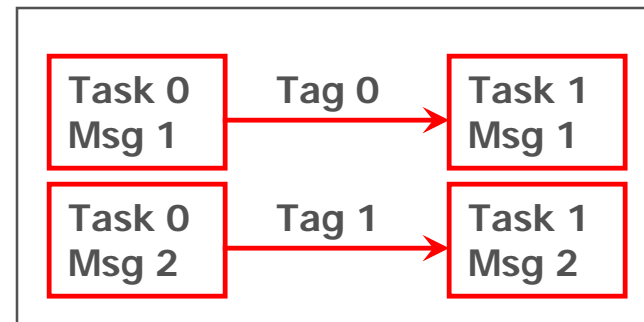

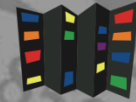

MPI Datatype	Fortran Datatype
MPI_BYTE	
MPI_CHARACTER	CHARACTER
MPI_COMPLEX	COMPLEX
MPI_DOUBLE_PRECISION	DOUBLE PRECISION
MPI_REAL	REAL
MPI_INTEGER	INTEGER
MPI_LOGICAL	LOGICAL
MPI_PACKED	

MPI Datatype	C Datatype
MPI_BYTE	
MPI_CHAR	char
MPI_DOUBLE	double
MPI_FLOAT	float
MPI_INT	int
MPI_LONG	long
...	...
MPI_PACKED	

- Initiates operation and returns
  - overlap communication with computation
  - receive requires 2 function calls – initiate the communication, and finish it
  - prepend function name with I and use request handle at the end of message
    - `call MPI_Irecv(n,1,MPI_INTEGER,i,0,MPI_COMM_WORLD,status,req,ierr)`
  - usually completed at the point when the communicated data are to be used
  - consume system resources, which must be released (MPI\_Wait, MPI\_Test)
    - `call MPI_Wait(req,status, ierr)`

# Example 2

## numerical integration



$$\int_a^b f(x) \approx \sum_{i=1}^n \frac{1}{2} h [f(x_{i-1}) + f(x_i)] =$$

$$\frac{1}{2} h [f(x_0) + f(x_n)] + \sum_{i=1}^{n-1} h [f(x_i)]$$

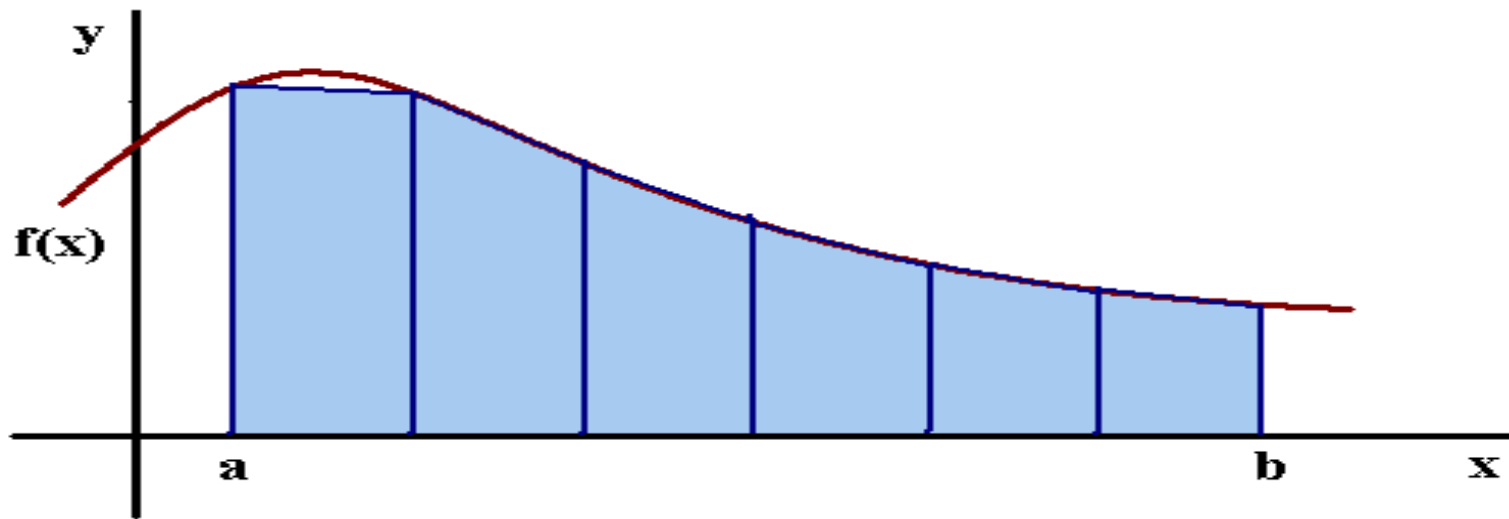

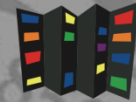

1. Initialize MPI
  2. Get interval and no. of trapezoids
  3. Broadcast input to all processes
  4. Each process calculates its interval
  5. Collect the results from all the processes
- New concepts:
    - collective communication – involves more processes
    - explicit work distribution
    - derived data types – more efficient data transfer



```
#include <stdio.h>
#include "mpi.h"
int main (int argc, char* argv[]){
int p, my_rank, n , i , local_n;
float a, b, h, x, integ, local_a, local_b, total;
MPI_Datatype mesg_ptr;
float f(float x);
void Build_der_data_t(float *a,float *b,int *n,MPI_Datatype
    *mesg_ptr);
```

1. `MPI_Init(&argc,&argv);`
2. `MPI_Comm_rank(MPI_COMM_WORLD, &my_rank);`  
`MPI_Comm_size(MPI_COMM_WORLD,&p);`  
`if (my_rank == 0) {`  
    `printf("Input integ. interval, no. of trap:\n");`  
    `scanf("%f %f %d",&a,&b,&n);}`
3. `Build_der_data_t(&a,&b,&n, &mesg_ptr);`  
`MPI_Bcast(&a,1,mesg_ptr,0,MPI_COMM_WORLD);`



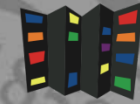

```
4. h = (b-a)/n; local_n = n/p;
   local_a = a + my_rank*h*local_n;
   local_b = local_a + h*local_n;

   integ = (f(local_a)+f(local_b))/2.;
   x = local_a;
   for (i=1;i<local_n;i++){
       x = x+h;
       integ = integ+ f(x);}
   integ = integ*h;
   printf("Trapezoids n = %d, local integral from ",local_n);
   printf("%f to %f is %f\n",local_a,local_b,integ);
   total = 0.;

5. MPI_Reduce(&integ,&total,1,MPI_FLOAT,MPI_SUM,0,MPI_COMM_WORLD);
   if (my_rank == 0)
       printf("Total integral = %f\n",total);
MPI_Finalize();
   return 0;}
```

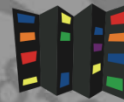

```
em001:~>% mpicc trapp.c -o trapp
em001:~>% mpirun -np 4 ./trapp
Input integ. interval, no. of trap:
0 10 100
Trapezoids n = 25, local integral from 0.000000 to
  2.500000 is 5.212501
Total integral = 333.350098
Trapezoids n = 25, local integral from 2.500000 to
  5.000000 is 36.462475
Trapezoids n = 25, local integral from 5.000000 to
  7.500000 is 98.962471
Trapezoids n = 25, local integral from 7.500000 to
  10.000000 is 192.712646
```

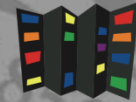

- Broadcast – from one node to the rest
  - `MPI_Bcast(buf, count, datatype, root, comm, ierr)`
  - `int MPI_Bcast(void *buf, int count, MPI_Datatype datatype, int root, MPI_comm comm)`

On `root`, `buf` is data to be broadcast, on other nodes it's data to be received

- Reduction – collect data from all nodes
  - `MPI_Reduce(sndbuf, rcvbuf, count, datatype, op, root, comm, ierr)`
  - `int MPI_Reduce(void *sndbuf, void *rcvbuf, int count, MPI_Datatype datatype, MPI_Op op, int root, MPI_comm comm)`

```
MPI_Reduce(&integ, &total, 1, MPI_FLOAT, MPI_SUM, 0, MPI_COMM_WORLD);
```

Supported operations, e.g. `MPI_MAX`, `MPI_MIN`, `MPI_SUM`,...

Result stored in `rcvbuf` only on processor with rank `root`.

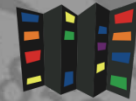

- Communication operations that involve more than one process
  - *broadcast* from one process to all the others in the group
  - *reduction* collect data from all the processes in certain manner (sum, max,...)
  - *barrier synchronization* for all processes of the group
  - *gather* from all group processes to one process
  - *scatter* distribute data from one process to all the others
  - *all-to-all gather/scatter/reduce* across the group
- NOTE: There is no implicit barrier before collective communication operations, but there is a barrier after

- Used to group data for communication
- Built from basic MPI data types
- Must specify:
  - number of data variables in the derived type and their length (1,1,1)
  - type list of these variables (MPI\_DOUBLE, MPI\_DOUBLE, MPI\_INT)
  - displacement of each data variable in bytes from the beginning of the message (0,24,56)

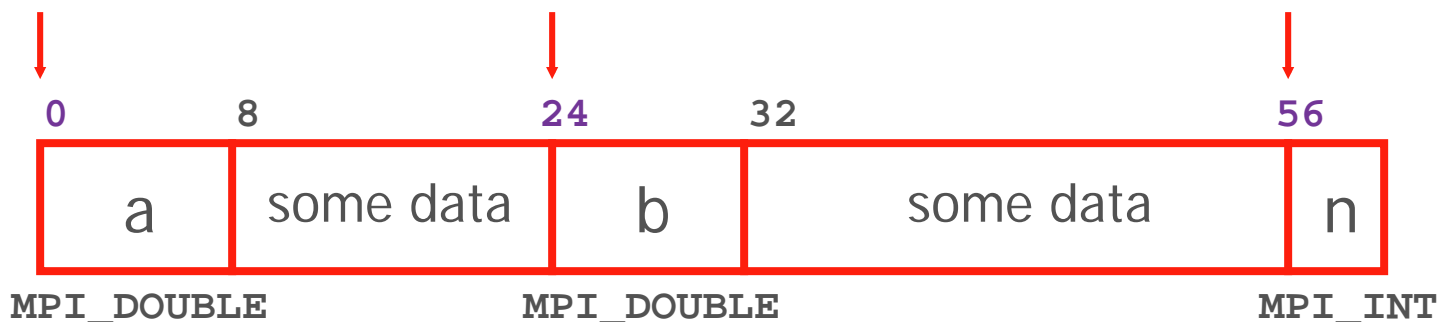

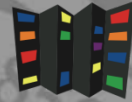

```
void Build_der_data_t(float *a,float *b,
                    int *n,MPI_Datatype *mesg_ptr){
int blk_len[3] ={1,1,1};
MPI_Aint displ[3], start_addr, addr;
MPI_Datatype type1[3]={MPI_FLOAT,MPI_FLOAT,MPI_INT};

displ[0] = 0;
MPI_Get_address(a,&start_addr);
MPI_Get_address(b,&addr);
displ[1] = addr - start_addr;
MPI_Get_address(n,&addr);
displ[2] = addr - start_addr;

MPI_Type_create_struct(3,blk_len,displ,type1,mesg_ptr);
MPI_Type_commit(mesg_ptr);
}
```

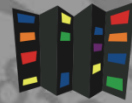

- Address displacement
  - `MPI_Get_address(location, address)`
  - `int MPI_Get_address(void *location, MPI_Aint *address)`
- Derived data type create
  - `MPI_Type_create_struct(count, bl_len, displ, typelist, new_mpi_t)`
  - `int MPI_Type_create_struct(int count, int bl_len[], MPI_Aint displ[], MPI_Datatype typelist[], MPI_Datatype *new_mpi_t)`  
`MPI_Type_create_struct(3, blk_len, displ, typel, mesg_ptr);`
- Derived data type commit/free
  - `MPI_Type_commit(new_mpi_t)`
  - `int MPI_Type_commit(MPI_Datatype *new_mpi_t)`
  - `MPI_Type_free(new_mpi_t)`
  - `int MPI_Type_free(MPI_Datatype *new_mpi_t)`



- Simpler d.d.t. constructors
  - `MPI_Type_contiguous`  
= contiguous entries in an array
  - `MPI_Type_vector`  
= equally spaced entries in an array
  - `MPI_Type_indexed`  
= arbitrary entries in an array



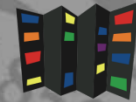

```
void Exch_data(float *a,float *b,int *n,int my_rank){
char buffer[100];
int position = 0;

if (my_rank == 0){
    MPI_Pack(a,1,MPI_FLOAT,buffer,100,&position,MPI_COMM_WORLD);
    MPI_Pack(b,1,MPI_FLOAT,buffer,100,&position,MPI_COMM_WORLD);
    MPI_Pack(n,1,MPI_INT,buffer,100,&position,MPI_COMM_WORLD);
    MPI_Bcast(buffer,100,MPI_PACKED,0,MPI_COMM_WORLD);}
else{
    MPI_Bcast(buffer,100,MPI_PACKED,0,MPI_COMM_WORLD);
    MPI_Unpack(buffer,100,&position,a,1,MPI_FLOAT,MPI_COMM_WORLD);
    MPI_Unpack(buffer,100,&position,b,1,MPI_FLOAT,MPI_COMM_WORLD);
    MPI_Unpack(buffer,100,&position,n,1,MPI_INT,MPI_COMM_WORLD);}
}
```

- Explicit storing of noncontiguous data for communication

- Pack – before send

- `MPI_Pack(pack_data, in_cnt, datatype, buf, buf_size, position, comm, ierr)`

- `int MPI_Pack(void *pack_data, int in_cnt, MPI_Datatype datatype, void *buf, int buf_size, int *position, MPI_comm comm)`

```
MPI_Pack(a, 1, MPI_FLOAT, buffer, 100, &position, MPI_COMM_WORLD);
```

- Unpack – after receive

- `MPI_Unpack(buf, size, position, unpack_data, cnt, datatype, comm, ierr)`

- `int MPI_Unpack(void *buf, int size, int *position, void *unpack_data, int cnt, MPI_Datatype datatype, MPI_comm comm)`

- `position` gets updated after every call to `MPI_Pack/Unpack`

```
MPI_Unpack(buffer, 100, &position, a, 1, MPI_FLOAT, MPI_COMM_WORLD);
```

- count and datatype
  - sending contiguous array or a scalar
- MPI\_Pack/Unpack
  - sending heterogeneous data only once
  - variable length messages (sparse matrices)
- Derived data types
  - everything else, including:
  - repeated send of large heterogeneous data
  - sending of large strided arrays



- Advanced point-to-point communication
- Specialized collective communication
- Process groups, communicators
- Virtual processor topologies
- Error handling
- MPI I/O
- Dynamic processes
- One sided communication

Distributed matrix-vector multiply,  $\text{vecout}[M]=A[M][M]*\text{vecin}[M]$

```
double _Complex out1[FNxy], out2[FNxy], *commbuf, *compbuf;
```

2 communication buffers +  
comm and comp pointers

```
for (iis=0; iis <= FNlocs; iis++) {
```

```
    if (iis%2==1) commbuf=out2; else commbuf=out1;
```

swap comm. buffer

```
    xind = iis*FNxy;
```

```
    MPI_Iallgatherv(&(vecin[xind]), FNxy, MPI_DOUBLE_COMPLEX, commbuf, counts,  
stride, MPI_DOUBLE_COMPLEX, MPI_COMM_WORLD,&allg_handle);
```

Gather **vecin** into **commbuf**

```
    if (iis%2==0) compbuf=out2; else compbuf=out1;
```

swap comp. buffer

```
    if (iis>0) {
```

```
        for (iir=0;iir<FNloc;iir++) {
```

```
            iy = iir*FNxy;
```

vector offset

```
            for (ip=0;ip<numprocs;ip++) {
```

```
                ia = iy + ipoffA[ip] * Fnxy*FNloc;
```

matrix offset

```
                for (ix=0;ix<FNxy;ix++)
```

```
                    vecout[iy+ix] += A[(ia+ix)] * compbuf[ipoffV[ip]+ix];
```

use current compbuf  
(part of vector vecin)  
in M-V product

```
            }
```

```
        MPI_Wait(&allg_handle,&allg_status);
```

```
    }}
```



<http://www-unix.mcs.anl.gov/mpi/>

Pacheco - Parallel Programming with MPI

Gropp, Lusk, Skjellum – Using MPI 1, 2

<https://computing.llnl.gov/tutorials/mpi/>



- Basics
- Point-to-point communication
- Collective communication
- Grouping data for communication
- XSEDE monthly workshop – MPI programming next Tue, Wed  
registration closes Friday 1pm

[http://www.chpc.utah.edu/short\\_courses/intro\\_mpi](http://www.chpc.utah.edu/short_courses/intro_mpi)

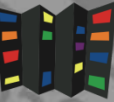

- No clear text passwords use ssh and scp
- You may not share your account under any circumstances
- Don't leave your terminal unattended while logged into your account
- Do not introduce classified or sensitive work onto CHPC systems
- Use a good password and protect it



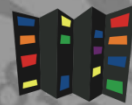

- Do not try to break passwords, tamper with files etc.
- Do not distribute or copy privileged data or software
- Report suspicious to CHPC ([security@chpc.utah.edu](mailto:security@chpc.utah.edu))
- Please see <http://www.chpc.utah.edu/docs/policies/security.html> for more details



- Debugging
  - Profiling
  - Mathematical Libraries at the CHPC
  - MPI-IO
  - Introduction to OpenMP
  - Hybrid MPI/OpenMP programming
- Survey

<https://www.surveymonkey.com/r/8GGBT78>